

KitchenAid®

Superba
Built-In Dishwasher
With Whisper Quiet™ System

**Models KUDS220T
KUDS22HT**

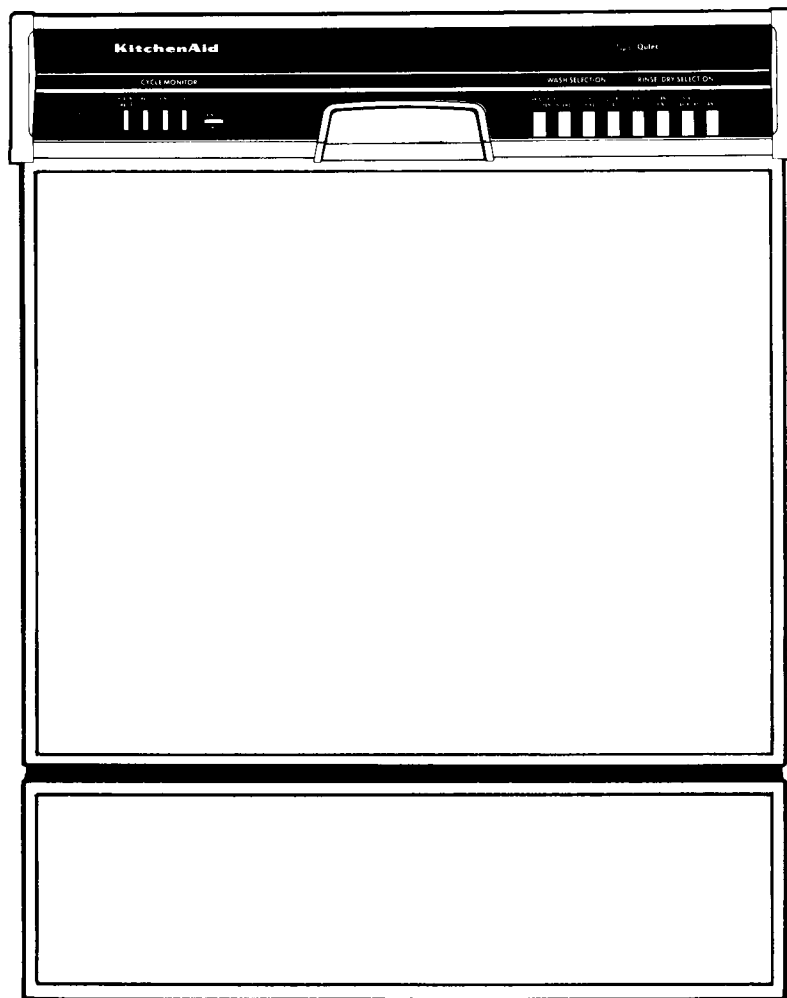

9-92

USE and CARE GUIDE

Table of Contents

Important Safety Instructions	3
Ownership Registration Card	4
Important Facts	4
Dishwasher Features	5
Operating Your Dishwasher	6
Sure-Temp™ Water Heating	6
Special Tips On Dishwasher Use	7
Dishwasher Cycles	8
To Cancel A Cycle	10
Adding Dishware During A Cycle	10
Energy Saving Tips	11
Loading Your Dishwasher	12
Upper Rack	13
Lower Rack	14
Silverware Basket	15
Filling The Detergent Dispenser	16
How Much Detergent To Use	17
Low Phosphate Detergents	18
Rinse Agents	18
Caring For Your Dishwasher	18
Seasonal Storage	19
Drain Air Gap	19
Sure-Scrub™ Wash System	20-21
Problem, Cause, Solution Chart	22-23
Removing Spots And Film	23
Changing Front Panels	24-26
Optional Front Panels	26
If You Need Service Or Assistance	27
Warranty	Back Cover

It is your responsibility to be sure your dishwasher:

- Is installed by a qualified installer.
- Has been installed where it is protected from the elements.
- Has been installed on a floor strong enough to support its weight.
- Has been properly connected to electricity, water and drain.*
- Has been properly electrically grounded.*
- Has had all hang tags and temporary labels removed.
- Is not used by children or anyone unable to operate it properly.
- Is properly maintained.

**See Installation Instructions for complete information.*

Heavy duty door springs are necessary when installing custom panels.

Failure to provide proper door springs with custom panels may cause damage to the dishwasher.

Important Safety Instructions

To reduce the risk of fire, electrical shock, or injury when using your dishwasher, follow basic precautions including the following:

1. Read all instructions before using the dishwasher.
2. This dishwasher must be properly connected to electricity and water.
3. Use the dishwasher only for its intended function.
4. Use only detergents and rinse agents recommended for use in a dishwasher, and keep them out of the reach of children.
5. When loading items to be washed:
 - a. Locate sharp items so that they are not likely to damage the door seal.
 - b. Load sharp knives with the handles up to reduce risk of cut-type injuries.
6. **DO NOT** wash plastic items unless marked "dishwasher safe" or the equivalent. For plastic items not so marked, check the manufacturers' recommendations.
7. **DO NOT** touch the heating element during or immediately after use. Element must cool at least 20 minutes to avoid injury.
8. **DO NOT** operate your dishwasher unless all enclosure panels are properly in place.
9. **DO NOT** tamper with controls.
10. **DO NOT** abuse, sit on or stand on the door or dish rack of the dishwasher.
11. To reduce the risk of injury, do not allow children to play in or on a dishwasher.
12. If hot water has not been used recently (usually two weeks or longer), hydrogen gases may build up in the water heater and the hot water pipes. **HYDROGEN GAS IS EXPLOSIVE.** To prevent injury or damage, before using your dishwasher, turn on all hot water faucets and allow water to run for several minutes. This will allow gases to escape. Do not smoke or use any open flame near the faucet while it is open.
13. When discarding an old dishwasher, always remove the door to prevent accidental entrapment.
14. Install the dishwasher on a floor that is level and strong enough to support the weight.
15. To prevent electrical shock, disconnect electrical power supply to dishwasher before attempting to service.

SAVE THESE INSTRUCTIONS

Ownership Registration

Before you use your dishwasher, please fill out and mail your ownership registration card. This card will enable us to contact you in the unlikely event of a product safety notification and assist us in complying with the provisions of the Consumer Product Safety Act. THIS CARD DOES NOT VERIFY YOUR WARRANTY.

Keep a copy of the bill of sale showing the date of purchase and /or date of installation of your dishwasher. PROOF OF PURCHASE WILL INSURE YOU OF IN-WARRANTY SERVICE.

Write down the following information. You will need it if your dishwasher ever requires service.

Model Number* _____

Serial Number* _____

Date Purchased _____

Date Installed _____

Dealer's Name _____

Address _____

Phone _____

*Model and Serial Numbers are located on a label at the left side of the door opening.

Important Facts

- KitchenAid dishwashers operate on 115 volts, 60 hertz A.C. house current. They cannot be converted to operate on 220 volts, 50 or 60 hertz house current.
- To protect against possible rupture of fill valve, BE SURE water lines leading to the dishwasher as well as water lines in the dishwasher are protected against freezing. Such ruptures are *not* covered by the warranty. See page 19.
- To prevent accidental entrapment, remove the door when removing an old dishwasher from service or discarding it.

Dishwasher Features

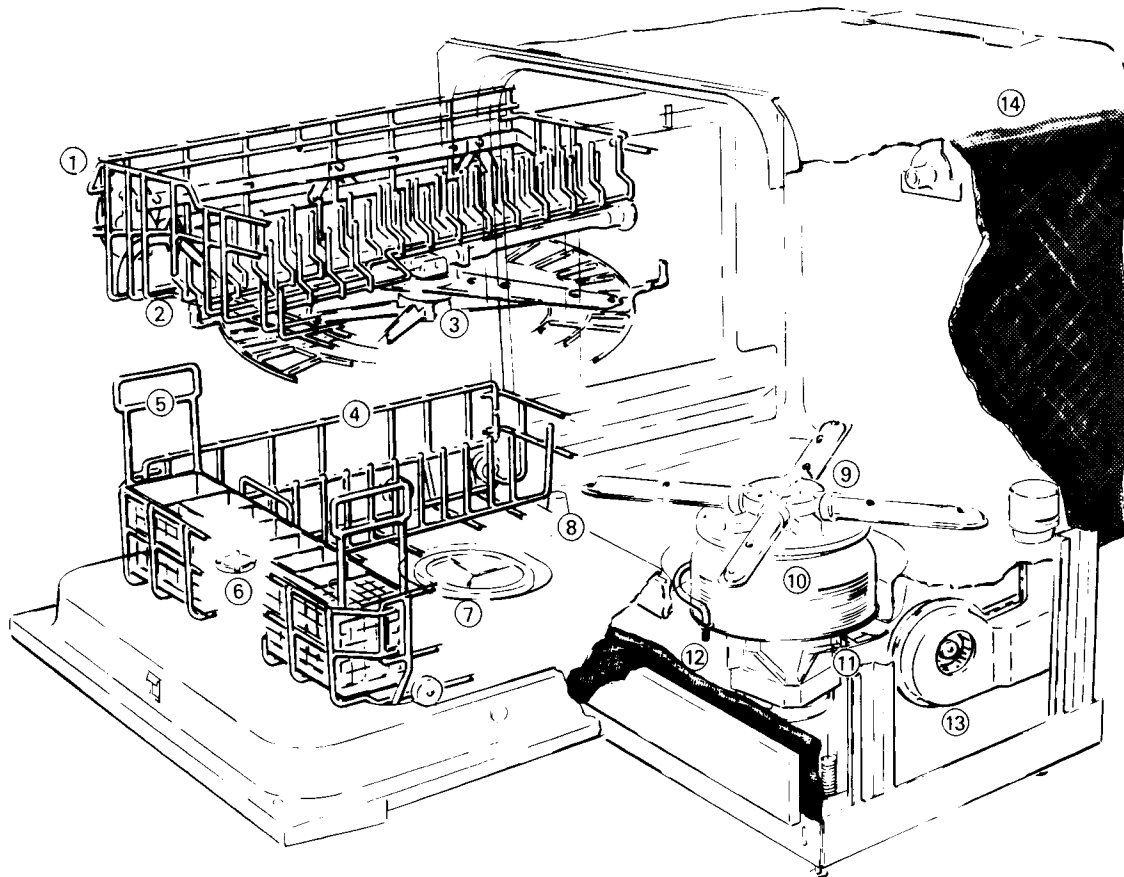

1. 16-Position Adjustable Upper Rack with Durakote™ Nylon
2. Stay-Put Flex-O-Dividers™
3. Upper Level Power Wash with ChinaGuard™
4. Lower Rack with Durakote™ Nylon
5. Cutlery/Silverware Basket
6. Automatic Rinse Agent Dispenser
7. Detergent Dispenser
8. Overflow Protection Float
9. 4-Way Hydro Sweep Wash
10. Self-Cleaning Filter with Jet Spray
11. Removable Coarse Strainer
12. Water-Heating Element
13. Flo-Thru™ Drying Fan/Heater
14. Triple Layer High Density Insulation

Operating Your Dishwasher

Step 1 Load dishes into racks according to instructions on pages 12-16.

Do not operate dishwasher without racks in place. Water leakage and flooding may result.

Step 2 Add detergent to detergent dispenser. See page 17.

Step 3 Firmly close the door and latch it by pushing the door handle down.

Step 4 Push button for desired cycle. See page 8 for description of cycles. The rest is automatic. The dishwasher will wash and dry dishware according to the cycle selected.



KitchenAid Whisper Quiet™ System

Your KitchenAid dishwasher is equipped with a unique sound reduction system. The Whisper Quiet™ System is designed to eliminate the common sounds heard while a dishwasher is operating. A triple layer of high density insulation brings you such an unusually quiet operation, you may wonder if your dishwasher is actually on.

Sure-Temp™ Water Heating

The first wash portion of the cycle selected (excluding Rinse and Hold, Light/China and Quick/Glass cycles) is delayed until the water is heated to approximately 140°F (60°C). This means that you can turn your home water heater down to provide a minimum of 120°F (49°C) incoming water to the dishwasher rather than 140°F (60°C) — saving you approximately 10% of your total household water heating energy.

If the water temperature inside the dishwasher is 120°F, it will take about 7 minutes to heat the first water fill to 140°F. Higher water temperatures will shorten the cycle time.

The WATER HEATING LIGHT will glow while water is being heated in the dishwasher, prior to the wash portion of the selected cycle. If the SANI RINSE option is selected, the WATER HEATING light will come on again while water is being heated, just prior to the last rinse of the cycle. No water circulation takes place during these water heating periods. The wash and/or rinse portion of the cycle is delayed until the water reaches the correct temperature.

For best dishwashing results, water should be at least 120°F (49°C) as it enters the dishwasher. To check the temperature, test it at the faucet closest to your dishwasher.

1. Setting the faucet control for the hottest water possible, run water into a glass set in the sink for at least one minute, allowing it to overflow.
2. Place a candy or meat thermometer in the glass and read it at the maximum setting.
3. If the temperature is too low, raise the setting on your water heater.

Special Tips on Dishwasher Use

What Can and Cannot Be Washed in Your Dishwasher

Most tableware, cookware and silverware can be safely washed in your KitchenAid dishwasher. If you have any doubts about a particular piece of dishware, check with the manufacturer to see if it is dishwasher safe.

REMEMBER: *It is the user's responsibility to determine if dishware should be washed in a dishwasher.*

Material	Dishwasher Safe?	Exceptions/ Special Information	Material	Dishwasher Safe?	Exceptions/ Special Information
Aluminum	Yes	High water temperature and detergents may affect finish of anodized aluminum.	Disposable Plastics	No	Cannot withstand high water temperatures and detergents.
Cast Iron	No	Seasoning will be removed, and iron will rust.	Plastics	Yes	Always check manufacturers' recommendations before washing. Plastics vary in their capacity to withstand high water temperatures and detergents.
China/ Stoneware	Yes	Always check manufacturers' recommendations before washing. Antique, hand-painted or over-the-glaze patterns may fade. Gold leaf may discolor.	Stainless Steel	Yes	Run a RINSE & HOLD CYCLE if not washing immediately. Prolonged contact with foods containing salt, vinegar, milk products or fruit juice could damage finish.
Crystal	Yes	Always check manufacturers' recommendations before washing. Some types of leaded crystal may etch with repeated washings.	Sterling Silver or Silverplate	Yes	Run a RINSE & HOLD CYCLE if not washing immediately. Prolonged contact with food containing salt, acid or sulfide (eggs, mayonnaise and seafood) could damage finish.
Gold	No	Gold-colored flatware will discolor.	Tin	No	May rust.
Glass	Yes	Milk glass will yellow with repeated dishwasher washing.	Wooden Ware	No	Always check manufacturers' recommendations before washing. Untreated wood may warp, crack or lose its finish.
Hollow-Handle Knives	No	Handles of some knives are attached to the blade with adhesives which may loosen if dishwasher washed.			
Pewter	No	High water temperatures and detergent may discolor or pit finish.			

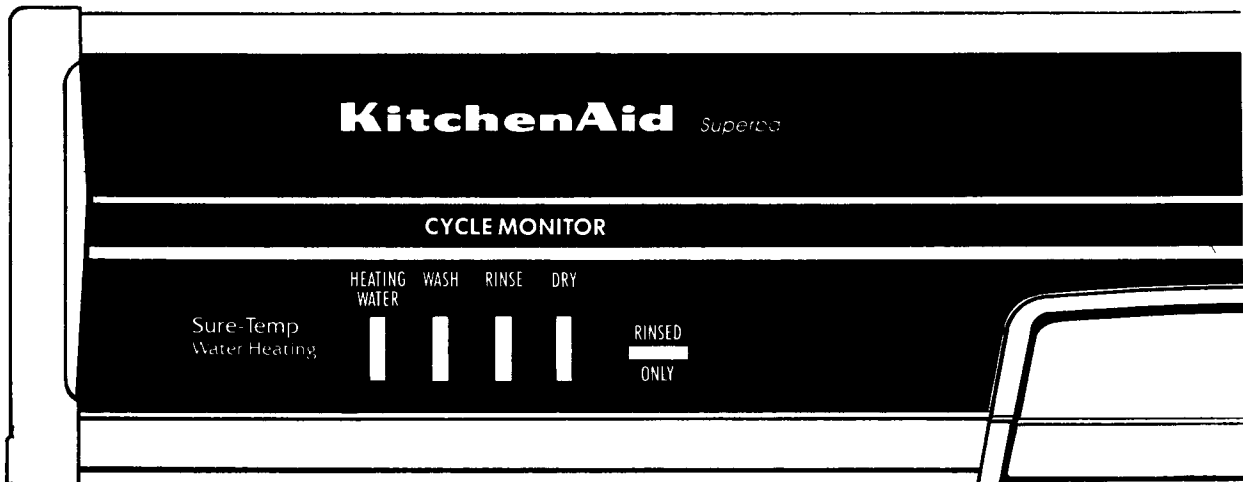

Dishwasher Cycles

Soak & Scrub, Pots/Pans Cycle is used to soak, wash and dry hard-to-clean heavily soiled pots, pans and casseroles along with regular tableware. Choose this cycle for your toughest jobs.

This cycle starts with a soak and scrub period, followed by two wash periods with two rinses, and a heated dry period.

CYCLE SEQUENCE	TOTAL CYCLE TIME (minutes)	WATER USED (gallons)
SOAK & SCRUB POTS & PANS 	90.5	12.25

Normal Wash Cycle is used to wash and dry daily loads with moderate amounts of food soil.

There are two wash periods and two rinses followed by a heated dry period.

CYCLE SEQUENCE	TOTAL CYCLE TIME (minutes)	WATER USED (gallons)
NORMAL WASH 	78	10

Light /China Wash Cycle is used to wash and dry daily loads with light amounts of food soil. This cycle uses less water and time than the Normal Wash Cycle and is the most efficient cycle to use.

There are two wash periods and two rinses followed by a heated dry period.

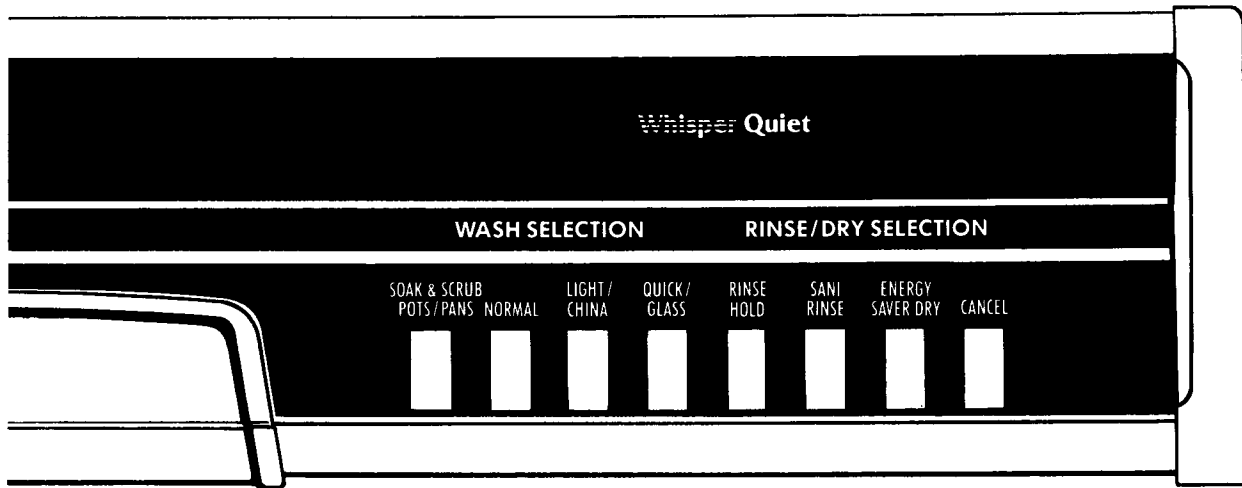

Light/China Wash Cycle (cont'd)

CYCLE SEQUENCE		TOTAL CYCLE TIME (minutes)	WATER USED (gallons)
LIGHT WASH		49.5	9.75

Quick / Glass Wash Cycle is used to rapidly wash and dry glassware, crystal, and lightly soiled china. This cycle starts with a rinse period, followed by one wash period with one rinse and a heated dry period.

Important: If ENERGY SAVER DRY (no heat) option is used, total cycle time is reduced by one-half. The SANI RINSE option cannot be used with the QUICK/GLASS cycle.

CYCLE SEQUENCE	TOTAL CYCLE TIME (minutes)		WATER USED (gallons)
	w/dry	w/o dry	
QUICK/GLASS WASH			7.5
	34.5	18	

Rinse & Hold Cycle is used to rinse partial loads of dishes until a full load is accumulated. No detergent is used. Dishware is kept moist until a complete wash and dry cycle can be run.

This cycle provides one rinse. The RINSED ONLY LIGHT will glow when the door is unlatched following this cycle — a reminder that the dishes have only been rinsed, not washed. The SANI-RINSE and ENERGY SAVER DRY options cannot be used with the RINSE & HOLD CYCLE.

Rinse & Hold Cycle (cont'd)

CYCLE SEQUENCE	TOTAL CYCLE TIME (minutes)	WATER USED (gallons)
RINSE & HOLD	6	2.25

Important: All cycles may be used to wash and dry dishwasher-safe china and crystal. Check manufacturers' recommendations before washing.

Sani-Rinse can be used with Normal, Light/China, and Soak & Scrub cycles to heat the final rinse water to approximately 160°F (71°C) to sanitize the dishware. This option will lengthen the cycle time 10.5 minutes.

Energy Saver Dry can be used with any Wash Selection to eliminate the heat during the dry portion of a cycle. The fan of the drying system will continue to operate, helping the dishes to air dry naturally. Under certain conditions, you may find a few drops of water on the dishware and silverware at the end of this cycle.

Cancel is used to cancel any cycle in progress. When this button is pushed, you will hear the sound of water draining. This is normal. The dishwasher will then automatically turn itself off. TO START A NEW CYCLE, wait until all indicator lights have gone off. Open door; check detergent dispenser to be sure it is properly filled, relatch door; select the desired new cycle.

Cycle Monitor Lights When the dishwasher is running, the lights indicate which portion of the cycle is being performed. Cycle has been completed when all lights are out.

Water Heating Light comes on when water in dishwasher is being heated to approximately 140°F (60°C). It also comes on for the last rinse of the Sani Cycle when the water is heated to approximately 160°F (71°C). Whenever the light is on, there is a pause in the wash action.

Rinsed Only Light comes on when door is unlatched after running the Rinse & Hold Cycle, indicating that the dishes have only been rinsed, not washed.

Adding Dishware During a Cycle You can add a forgotten item to the dishwasher anytime before the wash portion of the cycle. To stop the cycle, just unlatch the door handle. However, opening the door during a cycle lessens the cleaning power, so try to load all items before starting the cycle.

To Restart Dishwasher Close the door and latch the handle, push the cycle button originally selected and if desired, the Energy Saver button. The cycle will start exactly where it was stopped.

Energy Saving Tips

- Use the ENERGY SAVER DRY option whenever possible. If you don't need your dishes right away, it pays to air dry them.
- Flash dry dishes. Because of the heat buildup in dishware during the wash cycle, they can be flash dried (a process which causes water to evaporate very quickly). To flash dry your dishware, push CANCEL button shortly after dry light comes on; when dry light goes out, open the door and pull out the racks. REMEMBER: In hard water areas, flash drying can increase the likelihood of spotting and filming.
- Turn the temperature setting on your home water heater down to provide a minimum of 120°F (49°C) incoming water to the dishwasher.
- Run the dishwasher only with a full load.
- Do not rinse dishware before loading.
- Use only the cycle and options that you need.
- Run the dishwasher at night during the summer to avoid daytime heat load.
- Run the dishwasher during off peak (electrical) hours.

Just scrape leftover food, bones, toothpicks and other hard items from dishware. Some foods like eggs, rice, pasta, and cooked cereals may be hard to remove if they are left to dry over a period of time. If you do not plan to wash your dishes fairly soon after use, run a RINSE & HOLD CYCLE to keep them moist until you are ready to run the next wash cycle. Never prewash dishes with a liquid detergent. This type of detergent will cause over-sudsing in the dishwasher and will result in poor cleaning and/or spotting and filming on the dishware.

Always load dishware so that soiled surfaces face the rotating wash arm.

Durakote™ Nylon Upper and Lower Racks

Your KitchenAid dishwasher is equipped with DuraKote™ Nylon upper and lower racks with Cushion-Tips™ that provide extended life and better protection for your dishes. These racks have an extended five-year limited warranty. See your dishwasher warranty on back cover for details.

Adjustable Upper Rack

Your KitchenAid dishwasher features a 16-position upper rack which can easily be adjusted whether empty or full.

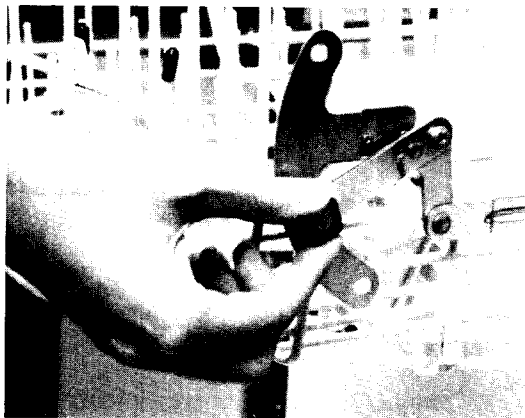

- Pull the upper rack out so the knobs on either side of the rack are easily reached.
- Pull knob on side of rack out from the retainer plate, raise or lower to desired level, and place knob pin into one of the four holes in the retainer.

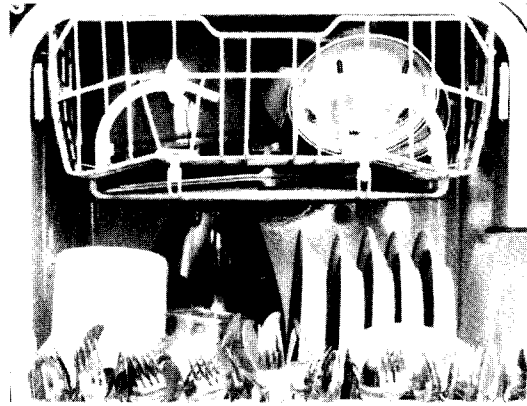

Use the high position when loading platters, trays, large roasting pans and other baking utensils in the lower rack

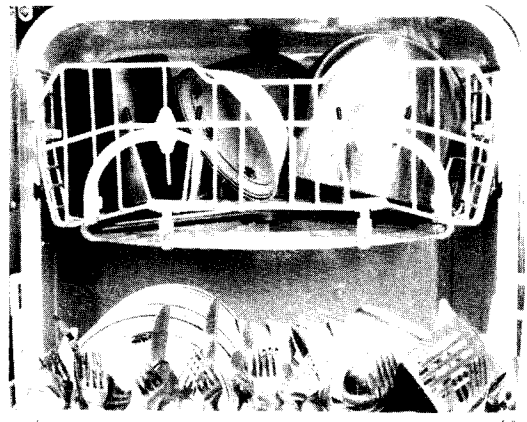

Use the low position when loading pitchers, deep bowls, and tall stemware in the upper rack.

For a Combination/Tilted Position

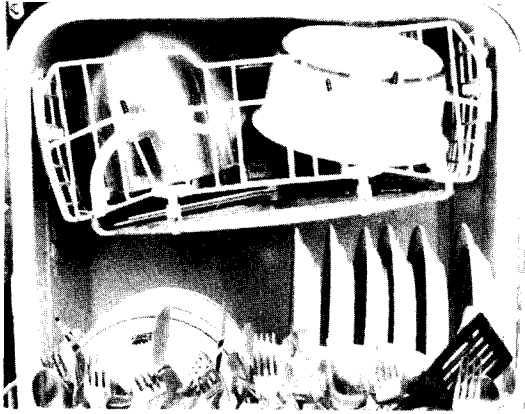

Either side of the rack may be raised or lowered independently of the other to accommodate extra large items in both racks.

Flex-O-Dividers™

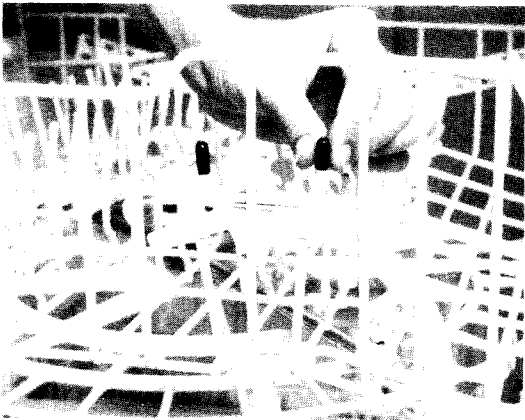

Two adjustable dividers are located on either side of the fixed center row pins. Each divider works independently of the other and can be changed to fit loading needs. To adjust, place thumb and index fingers on pin and secure pin into selected notch or fold divider down flat. The outside row folds towards the outside of the rack, and the inside row folds towards the center pins.

Upper Rack Loading Examples

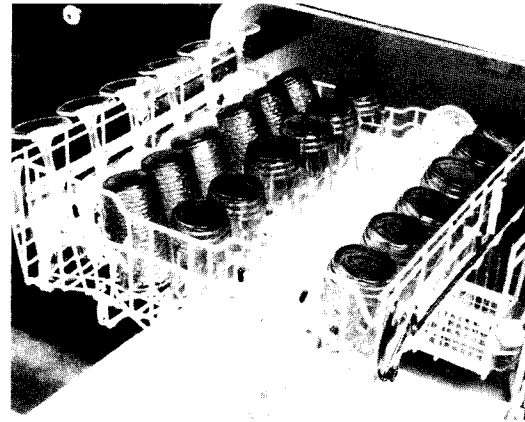

- Lightweight plastics, or glassware and stemware should be locked into place using the outside row of Flex-O-Dividers™. Additional glasses, and stemware, may also be loaded in the upper rack between and over pins in a stable manner.

CAUTION

Be sure items are stable. If load is not stable, damage may occur.



- Glasses, stemware, bowls, pans, saucers and cups may be loaded together. Stability is important when loading such items. Tilt cups and mugs with concave bottom surfaces to aid drainage.

Lower Rack Loading Examples

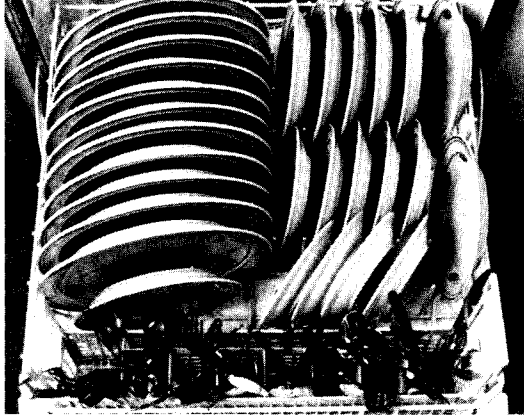

- For maximum capacity and stability of an all-plate load, overlap or "butterfly" small plates on right side, as shown

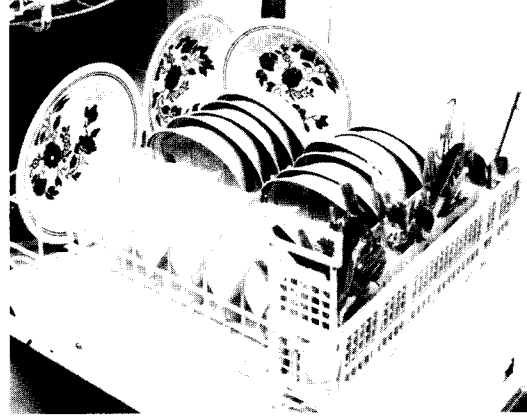

- Cereal/soup bowls may be loaded in a variety of ways, depending upon the shape of the bowls.

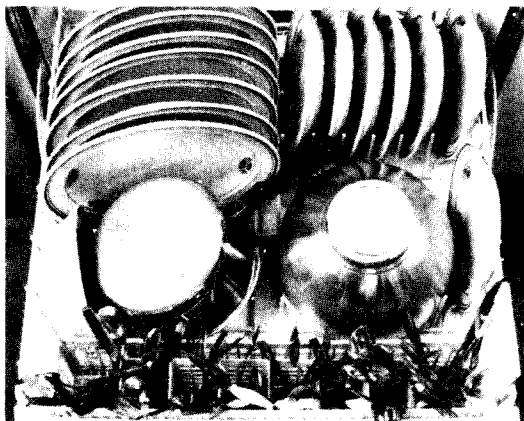

- Plates may be loaded front to back or side to side with pots, pans and large cookware.

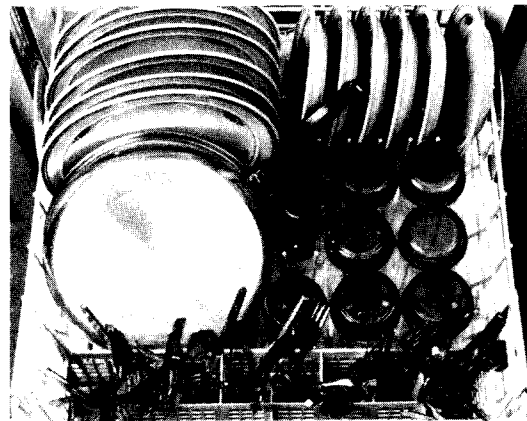

- Glasses may be loaded in the lower rack along with plates, bowls and saucepans.

Silverware Basket

The silverware/cutlery basket can be removed for loading and unloading.

For best washing results:

- Load slim handled silverware with handles up to prevent them from sticking out through the basket, possibly causing damage to the silverware or dishwasher.

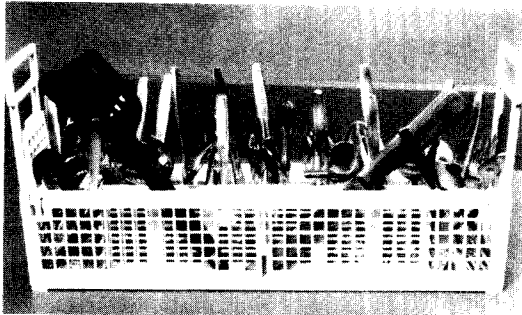

- Load forks and spoons with handles up and down so they do not nest together. Nested items cannot be properly washed.

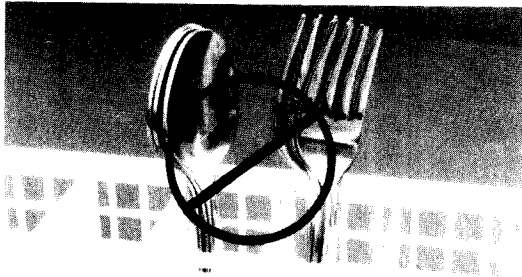

WARNING

Personal Injury Hazard

Sharp utensils should be loaded with handles up to prevent possible injury.

- The cutlery section in the front of the basket is for long-handled utensils and long knives.

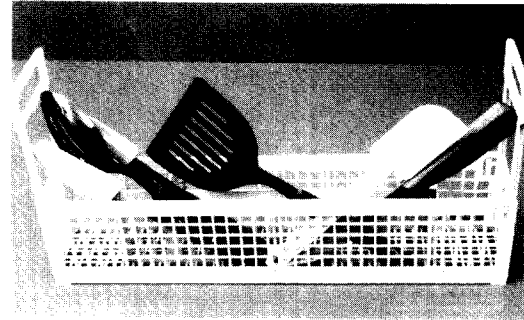

CAUTION

Silver and stainless steel flatware may be damaged if exposed to foods containing salt, vinegar, milk products or fruit juices for long periods of time. Use the RINSE & HOLD CYCLE if flatware is not washed immediately after use.

Small Items Section

- A small items section, with lid, is provided in the silverware basket. This can be used for baby bottle nipples, corn holders, measuring spoons, and other small items. With lid in upright position this section can be used for additional silverware.

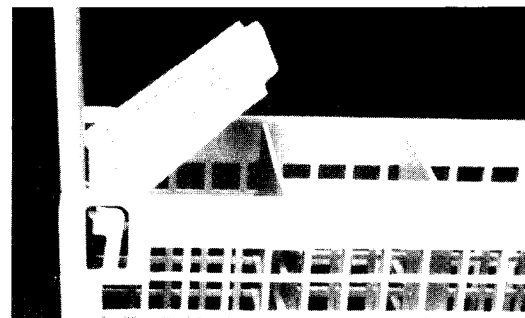

Silverware Basket (cont'd)

Plate Lift Out Section

- The plate lift out section provides added versatility for racking. There are two positions available (C and D).

To Remove: Push back handle (A) to unhook from locking position and lift up and out.

To Replace: While holding handle, position rear of section (B) under back of top cross wire and slip detent (locking device C) into proper retainer (D) or (E).

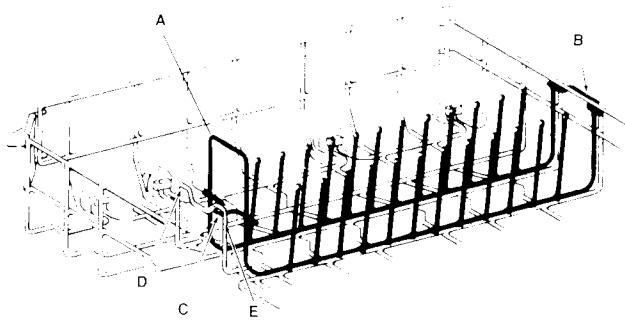
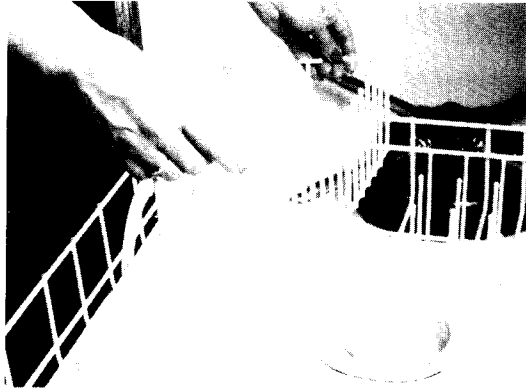

- The silverware basket can be relocated in the lower rack for additional loading flexibility. By positioning plate lift out section into rack retainer on right side (see plate lift out illustration), the basket can be located along the left side (front to back) of the lower rack.



1. **USE AUTOMATIC DISHWASHER DETERGENTS.** Never use soap, hand dishwashing detergent, laundry detergent or laundry enzyme products. They will produce excessive suds and slow down the wash arm action which could cause flooding.

2. Add detergent to the dispenser immediately before starting. Detergent exposed to moisture over a period of time may become caked and ineffective. An open box of detergent should stay fresh for about one month.

3. Fill the dispenser with the proper amount of detergent, and close the compartment. The indentation is used for the SOAK AND SCRUB POTS/PANS CYCLE ONLY.

Single Fill

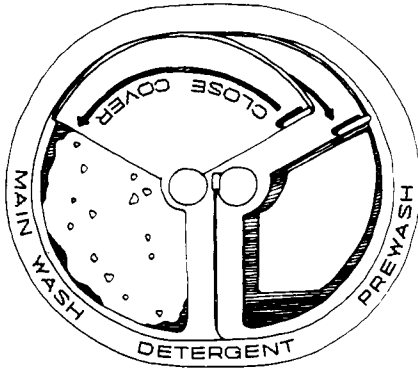

Single Fill is used for the Light/China Wash Cycle and Quick/Glass Wash Cycle when dinnerware is lightly soiled.

Double Fill

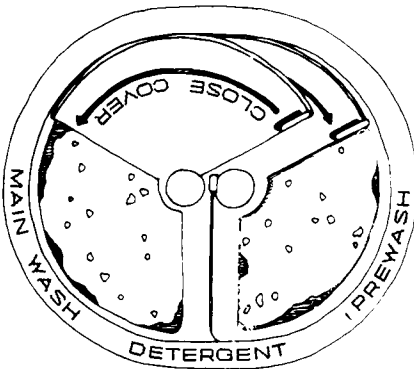

Double Fill is used for the Normal Wash Cycle and may also be used for the Light/China Wash Cycle.

Triple Fill

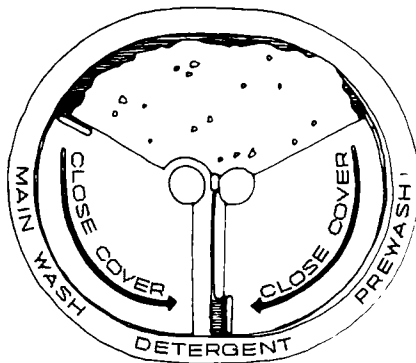

Triple Fill is used for the Soak & Scrub, Pots/Pans Cycle only.

How Much Detergent To Use

Personal Injury Hazard

Dishwasher detergents and rinse agents can be harmful if taken internally. Store these products out of children's reach.

ALWAYS use at least one tablespoon of automatic dishwashing detergent in Main Wash compartment because there are ingredients in detergent to help protect your dinnerware. The amount of detergent needed depends on the amount of food soil on the dishes and the hardness of water. If you have hard water, you will have to use more detergent than if you have soft water. Excessive amounts of detergent combined with soft water may cause etching of glass. Contact your local water utility, area water softening company or state university extension agent to determine whether your water is hard or soft.

Water Hardness	Amount of Detergent
Soft Water 0-4 grains per gallon	Fill each dispenser half full (approximately 2 tablespoons per dispenser)
Medium Hard Water 4-8 grains per gallon	Fill each dispenser $\frac{3}{4}$ full (approximately $2\frac{1}{2}$ tablespoons per dispenser)
Hard Water 8-12 grains per gallon	Fill each dispenser completely (approximately 3 tablespoons per dispenser)

Low Phosphate Detergents

If you live in a state that mandates low-phosphate dishwasher detergents (phosphate content of 8.7 percent or less), you may have to use more detergent, particularly if you have hard water. Low-phosphate detergents usually work well in soft water, but in hard water they can cause spotting and filming, even if the amount of detergent used is increased.

Rinse Agents

Your dishwasher uses a liquid rinse agent. A rinse agent helps water to sheet off dishware faster than normal, reducing water spots and speeding up the drying process.

To fill the rinse agent dispenser, unscrew the cap located to the left of the detergent dispenser. This reservoir will hold 7 fluid ounces of rinse agent, enough to last a few months. Be sure to replace the cap after filling the reservoir. A small amount of rinse agent is automatically released during the final rinse. Liquid rinse agents such as JET-DRY® are available in your local supermarket.

Caring For Your Dishwasher

General Cleaning

The porcelain enamel interior of your dishwasher will seldom need cleaning. However, if mineral deposits from hard water accumulate, clean the interior with a mild scouring powder or follow the suggestions indicated in the "Removing Spots and Film" section on page 23.

DO NOT use any type of cleanser that may cause foaming or sudsing. Run the dishwasher through a normal cycle.

The control panel can be wiped clean with a damp cloth, then dried. NEVER use detergents or abrasive or powdered cleansers which can mar the finish.

The enamel or wood fronts and sides can be cleaned with a soft cloth and a mild, non-abrasive soap and water solution. NEVER use paper towels for cleaning. Always dry with a soft cloth.

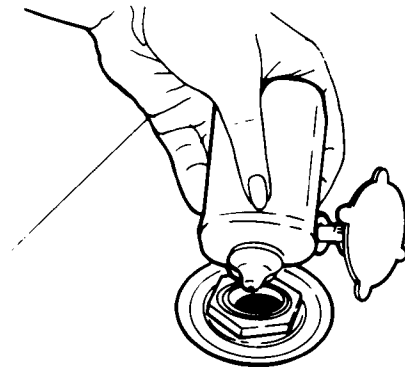

Seasonal Storage

The Summer Season:

Two simple steps will safeguard your KitchenAid dishwasher during an idle summer:

1. Turn off the water supply.
2. Turn off electricity to the dishwasher.

The Winter Season:

To protect against possible rupture of fill valve, BE SURE water lines leading to, as well as in the dishwasher, are well protected against freezing. RUPTURES OF THIS KIND ARE NOT COVERED BY THE WARRANTY.

To safeguard your KitchenAid dishwasher when it is exposed to freezing temperatures in a seasonal dwelling, have a local qualified person do the following:

1. Close and latch the door.
2. Turn off electricity to the dishwasher.
3. Shut off water supply. Place pan under fill valve, and disconnect fill valve at both inlet and outlet sides. Drain water into pan.
4. Place a pan under the drain valve outlet, and disconnect the flexible tubing at the drain valve. Drain machine water into pan. Leave fill and drain valve disconnected.

To restore service, reconnect the fill valve and the connection at the drain valve. Turn on the electricity and the water supply. Close and latch the door. Select the QUICK/GLASS WASH CYCLE and let the machine complete its cycle. Check connections to make sure they are water tight and do not leak.

Drain Air Gap

Some state or local plumbing codes require the addition of a drain air gap between a built-in dishwasher and the home drain system. This device protects your dishwasher against water backing up into it when a drain clogs. The drain air gap is usually located on top of the sink or countertop near the dishwasher. Drain air gap accessory part number 300096 is available from KitchenAid.

REMEMBER: This external plumbing device is not part of your KitchenAid Dishwasher.

To Clean the Drain Air Gap:

Clean the drain air gap periodically to insure proper drainage of your dishwasher. Follow drain air gap cleaning instructions provided by the manufacturer. With most types, just lift off the chrome cover, unscrew the plastic cap, and then check for any buildup of soil. Clean, if necessary.

Check the Air Gap Anytime Your Dishwasher Isn't Draining Well

REMEMBER: The warranty provided with your dishwasher does not cover service costs directly associated with the cleaning or repair of the external drain air gap.

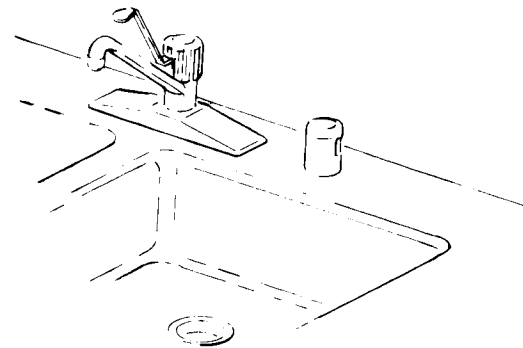

Sure-Scrub™ Wash System

The Sure-Scrub™ Wash System in your dishwasher provides excellent cleaning results. The wash water is continuously filtered by a triple filtration and soil collector system to prevent food particles from redepositing on clean dishes. The triple filtration system consists of a removable filter (A), an ultrafine filter (B) and a removable coarse strainer (C).

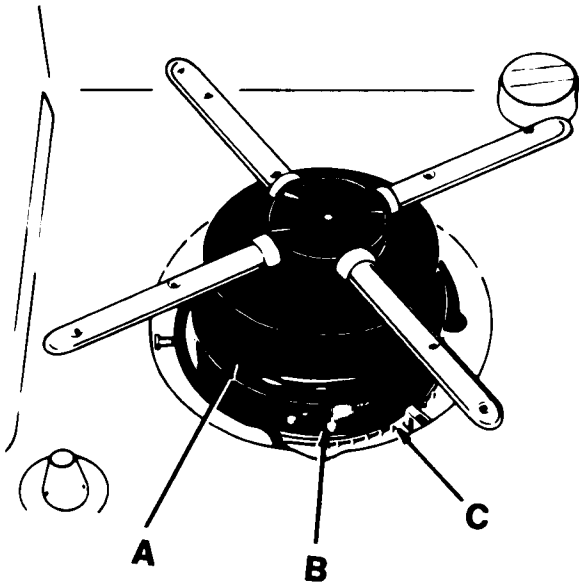

The removable filter continuously filters the wash water and traps the food particles that have been removed from the dishes on the outside of the filter. These trapped food particles are removed from the filter by the jet spray action of water from the single spray nozzle (D) underneath the wash arm. The ultrafine filter is cleaned by the nine water jets (E) underneath the 4-Way Hydro Sweep Wash Arm.

The removable coarse strainer (C) prevents bones, pits and other large objects from entering the pump system. Occasionally check the strainer for such items that may have mistakenly gotten into the dishwasher.

The 4-Way Hydro Sweep Wash Arm, the removable filter and the coarse strainer may be removed and cleaned if necessary. If food soils remain on the removable filter, lift the

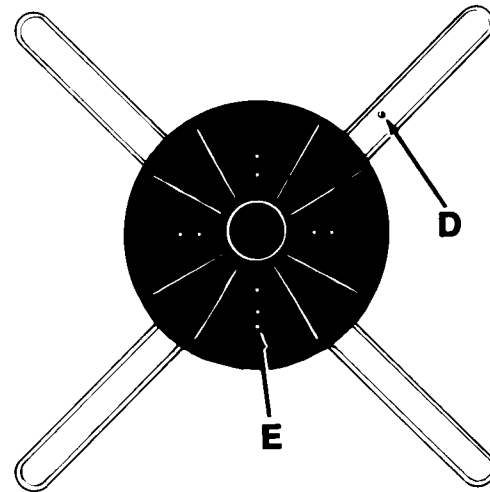

4-Way Hydro Sweep Wash Arm straight up. Check underside of wash arm to make sure the opening of the single stainless steel spray nozzle (D) and the nine water jets (E) are not blocked.

Next, remove the removable filter, by lifting the filter straight up and out. TO CLEAN, scrub filter with a stiff brush under running water. TO REPLACE, snap removable filter over the ultrafine filter and then replace the wash arm. When replacing wash arm, be sure that water jets on the wash arm are facing up.

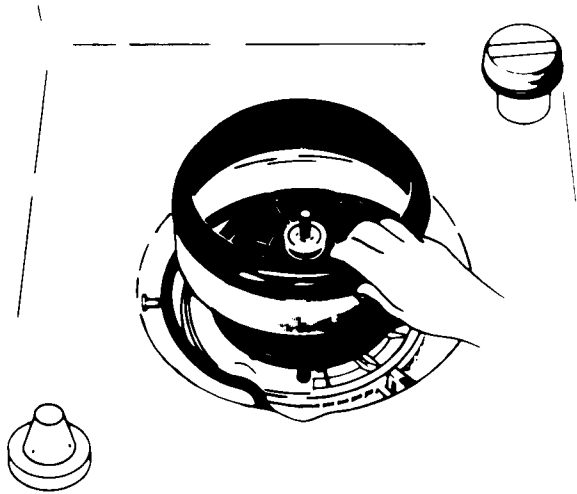

The Overflow Protection Float (G) in the front left corner of the dishwasher tank prevents the dishwasher from overflowing. The float must be in place for the dishwasher to operate.

Important: A small amount of water always remains in the sump (under the ultrafine filter) to keep the seal moist.

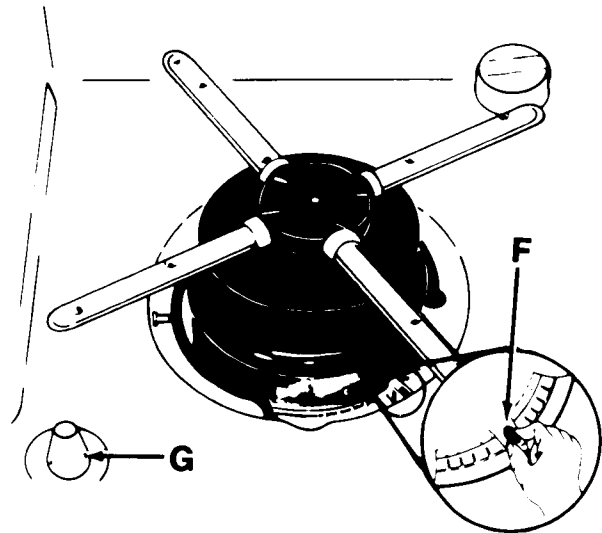

The coarse strainer may be removed, if necessary, without removing the other filters. TO REMOVE, lift strainer out by squeezing center section (F) and remove. TO REPLACE, squeeze center section so clips snap into square notch.

Possible Burn Hazard

Heating element will be hot immediately following use. Do not touch. To avoid burns wait at least 20 minutes after a cycle for the heating element to cool down.

Problem, Cause, Solution Chart

A convenient checklist for handling minor performance problems. Go over this list before calling for service. If you can't solve your dishwasher's problem, turn to page 27 for service information.

PROBLEM	CAUSE	SOLUTION
Food Soil Left On Dishes	Slowdown of wash arm due to high suds	Use recommended dishwasher detergents only. Never use soap or laundry detergents. Add more dishwasher detergent to increase amount of suds-inhibitors.
	Improper loading	Follow loading instructions in dishwasher Use and Care Guide.
	Low water pressure due to insufficient fill	Home water pressure should be 20 to 120 psi for proper dishwasher fill. A booster pump on the water supply may be necessary if pressure is too low.
	Use of incorrect, too little or ineffective detergent	Use recommended dishwasher detergents only. Follow recommendations in Use and Care Guide for amounts; never use less than one tablespoon per load. Detergent must be fresh to be effective. Always store it in a cool, dry area, preferably in an airtight container.
	Detergent cakes in dispenser	Use fresh detergent only. Do not allow detergent to sit for several hours in a wet dispenser. Have dispenser checked to make sure it is working properly.
	Water temperature is too low	Turn home water heater up so water entering dishwasher is 120°F (49°C) minimum. See recommended procedure "Sure-Temp™ Water Heating," page 6. Do not select ENERGY SAVER-NO HEAT.
Spotting and Filming	Filter cleaning spray nozzle on wash arm is blocked	Remove lower wash arm and turn upside down. Check single stainless steel spray nozzle and nine water jets located on underside of wash arm. See page 20. If openings are blocked clean out with a toothpick.
	Hard water or high mineral content in water	Conditioning the final rinse water with a liquid rinse agent helps eliminate spotting and filming. Keep the dispenser full with a rinse agent, such as JET-DRY®, at all times.
	Water temperature is too low	Turn home water heater up so water entering dishwasher is 120°F (49°C) minimum. See recommended procedure "Sure-Temp™ Water Heating," page 6.
	Use of incorrect detergents	Use recommended dishwasher detergents only.
	Incorrect amount of detergent	Follow recommendations in dishwasher Use and Care Guide for amount. Heavy soil and/or hard water generally require extra detergent.
Use of ineffective detergents	Detergent should be fresh. Store in a cool, dry place, preferably in an airtight container. Discard lumpy detergent.	
Cycle Takes Extremely Long Time	Insufficient fill caused by low water pressure	Home water pressure should be 20 to 120 psi for proper dishwasher fill. A booster pump on the water supply may be necessary if pressure is too low.
	Water temperature is too low.	Turn home water heater up so water entering dishwasher is 120°F (49°C) minimum. See recommended procedure "Sure-Temp™ Water Heating," page 6.
Dishes Do Not Dry Completely	Dishes do not drain properly	Dishes must have proper water drainage. Do not overload. Follow instructions for loading in dishwasher Use and Care Guide. Use a liquid rinse agent to speed draining.
	Plastics	Some plastics, due to material, may need to be towel dried.
Silica Film or Etching (Silica Film is a White Iridescent Deposit; Etching is a Cloudy Film)	A water chemical reaction with certain types of glassware. Usually caused by some combination of soft or softened water, alkaline washing solutions, insufficient rinsing, overloading the dishwasher, and heat of drying.	It may not be possible to prevent problem, except by hand washing. To retard this process, use a minimum amount of detergent but not less than one tablespoon per load. Use a liquid rinse agent and underload the dishwasher to allow thorough rinsing. Silica film and etching are permanent and cannot be removed. Use ENERGY SAVER DRY.

Black or Gray Marks on Dishes	Aluminum markings	Aluminum pieces should be loaded so that they will not rub against dinnerware during washing. Throw-away aluminum items should not be dishwasher washed because they may break down and cause marking. Aluminum markings can be removed by using a mild abrasive cleanser.
Brown Stains on Dinnerware and Dishwasher Interior	High iron content in water supply	Remove by washing dishes (after food soil has been removed) with 1 teaspoon to 1 tablespoon of citric acid crystals added to Main Wash compartment of detergent dispenser. Do not use detergent. Follow with a LIGHT/CHINA WASH CYCLE with detergent. If treatment is needed more often than every other month, the installation of an iron removal unit is recommended.
White Spots on Cookware with Non-Stick Finish	Seasoning removed by dishwasher detergents	Re-season cookware after dishwasher washing.
Odor in the Dishwasher	Dishes only washed every two to three days	Run a RINSE & HOLD CYCLE at least once or twice a day until a full load is accumulated.
Chipping of Dishware	Improper loading	Load dishes and glasses so that they are stable and do not strike together from washing action. (Note: Some types of china and glassware are too delicate for automatic dishwashing and should be hand washed; for example: antiques, featheredged and similar types.) Moving racks in and out smoothly will also minimize chipping.
Stainless Steel Filter Needs Frequent Cleaning	Filter is not placed in dishwasher correctly	Make sure Removable Filter is seated properly under wash arm. See page 21.
	Spray nozzle on wash arm is blocked	Remove lower wash arm — see page 20 — and turn upside down. On under side of each tube is an indentation. In one of these indentations is a nozzle (hole) which cleans filter. Check to make sure the nozzle is not blocked.
	Dishes not scraped before loading	Make sure leftover food, bones, toothpicks and other hard items are scraped from dinnerware before loading.

Removing Spots and Film:

To remove spots and film on dishware and glasses, or hard water film on the interior of the dishwasher, you may want to use stripping products. These products are available in the detergent section of your local grocery store; follow the manufacturers' directions.

Or you may use vinegar with the following procedure:

1. Load clean dishes and glasses in dishwasher in regular manner. Do not load silverware or other metals in the dishwasher.
2. Close and latch door and select LIGHT/CHINA WASH CYCLE. Do not use detergent. Allow dishwasher to run through the first wash. When washer has filled for main wash portion of cycle, unlatch and open door. Add 2 cups of household vinegar. Close and latch door and re-select LIGHT/CHINA WASH CYCLE.
3. After final rinse water has drained, cancel cycle. Do not allow dishwasher to go through dry portion of cycle.
4. For a final polish, put two tablespoons of non-precipitating type water conditioner in the right-hand Main Wash compartment of detergent dispenser, and run dishwasher through complete LIGHT/CHINA WASH CYCLE.

Changing Front Panels

Your new KitchenAid dishwasher comes with a stainless steel trim kit and two front panels installed one behind the other. You can choose from black or white (front and back of one panel) and almond or harvest wheat (front and back of the second panel).

If you want to change the color of the panels, follow one of the options below:

OPTION A may be used if your dishwasher front protrudes several inches from the cabinets.

OPTION B may be used if your dishwasher front is flush with the cabinets.

Electrical Shock Hazard
Disconnect electrical power supply to dishwasher before changing panels.
Failure to do so could result in electrical shock or personal injury.

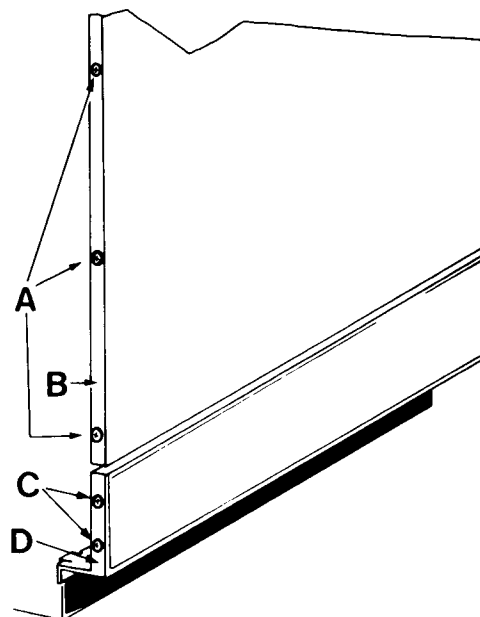

OPTION A

Upper Panel:

1. Disconnect electrical power supply.
2. Pull door open and on either side of the dishwasher door, remove the three screws (A) from the trim (B). Remove the loosened piece of trim.
3. Slide the color panel out. Handle carefully so the panel will not be scratched or bent. Turn the panel to the desired color. Place the color panel in position then push the filler panel in behind it.
4. Replace the trim (B) and the three screws (A).

Lower Panel:

1. Remove the two screws (C) on either side of the lower panel. Remove the loosened piece of trim (D).
2. Slide the panel out. Handle carefully so the panel will not be scratched or bent. Turn the panel to the desired color. Place the color panel in position then push the filler panel in behind it.
3. Replace the trim (D) and the two screws (C).
4. Reconnect electrical power supply.

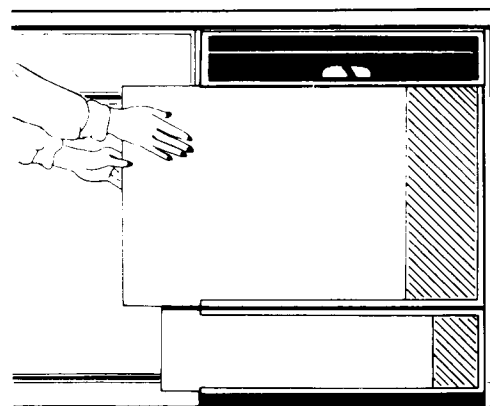

OPTION B

Upper Panel:

1. Disconnect electrical power supply.
2. Pull door open. Remove the two screws (A) on each side of the dishwasher door that secure the upper panel assembly.
3. Close door while holding upper panel in place. Pull out lower edge of panel until top edge of panel drops down.
4. Place panel assembly on a smooth, flat surface and remove three screws (B) from either side of panel to remove the trim strip (C).
5. Slide the panel out. Handle carefully so the panel will not be scratched or bent. Turn the panel to the desired color. Place the color panel in position then push the filler panel in behind it.
6. Replace the trim strip and the three screws.
7. With hands placed at sides of panel, slide the top edge of the panel up into position under the control panel (see illustration to the right).
8. Hold the panel in place and open the door.
9. Hold panel assembly in position with one hand. Replace the two screws (A) on each side of the dishwasher door that secure the panel assembly.

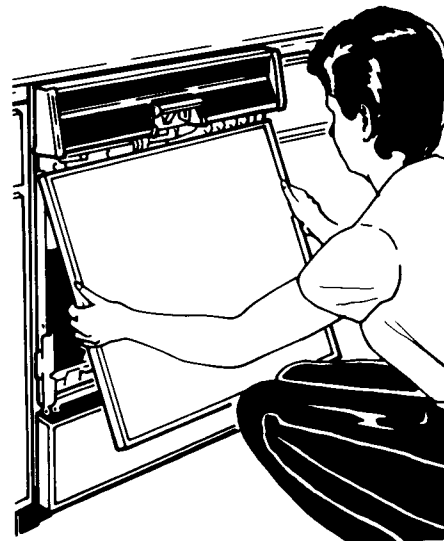
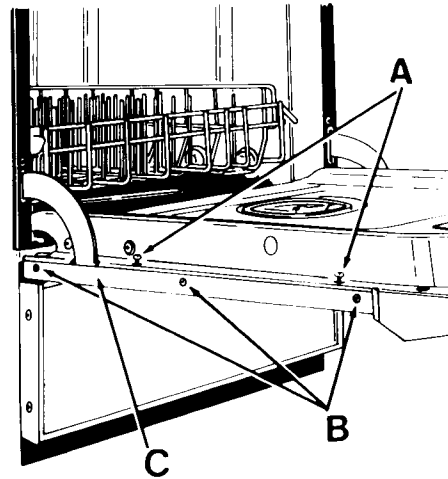

Lower Panel:

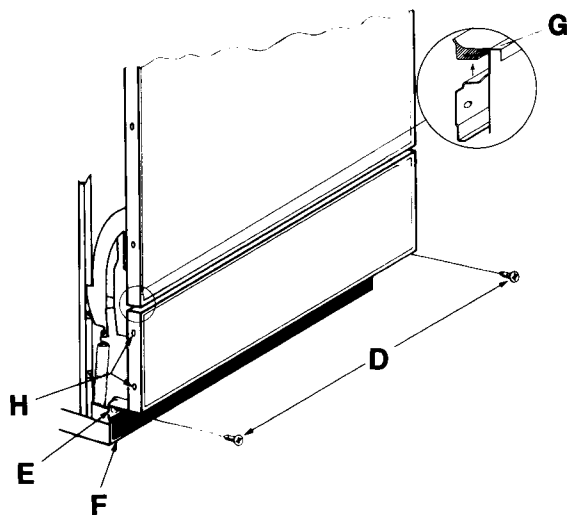

1. Remove two screws (D) located under the access panel.
2. Pull bottom of panel out and lift up and away from dishwasher.
3. Place panel on a smooth, flat surface and remove the two screws (H) from either side of the trim. Take off the loosened piece of trim.
4. Slide the color panel out. Handle carefully so the panel will not be scratched or bent. Turn the panel to the desired color. Place the color panel in position then push the filler panel in place.
5. Replace the trim and screws (H).
6. Taking the assembled lower panel, insert the top of access panel until it is seated properly on support bracket (G).

7. Replace the screws (D).

8. Check that upper and lower panels are secure.

9. Reconnect electrical power supply.

Optional Front Panels

1. Wood and Decorative Panels

The stainless front trim will accommodate a custom wood front or a decorative panel insert, ¼ inch thick. Some wood panels and decorative panels are heavy and require heavy dishwasher door springs. These may be ordered from your KitchenAid dealer as a service item. For more information on installing a custom wood front, refer to the Dishwasher Installation instructions. If you have misplaced these instructions, please write to:

Customer Relations Department
KitchenAid
P.O. Box 558
St. Joseph, MI 49085-0558

2. Solid Colors

If the four colors provided with your dishwasher do not match your kitchen decor, optional panels are available from your KitchenAid dealer in a variety of decorator colors.

If You Need Service or Assistance

Follow These Steps

1. If your dishwasher should fail to operate, review the following list before calling your dealer. You could save the cost of a service call.
 - Has the fuse blown, or is the circuit breaker open?
 - Is the door closed and latched, and a cycle selected?
 - Is the overflow protection float in place? See page 21.
 - Is the water supply to the dishwasher turned on?
2. If your dishwasher is not washing properly, refer to the Problem, Cause, Solution chart on page 22 before you make a service call.
3. If the problem is not due to one of the above items, first call your dealer or repair service he recommends.
 - All service should be handled locally by the dealer from whom you purchased the unit or an authorized KitchenAid servicer.
4. In the event you are unable to obtain the name of a local authorized KitchenAid servicer, call KitchenAid Consumer Affairs, **TOLL FREE: 800-422-1230**.
 - A Consumer Affairs representative can recommend a qualified service company in your area.
- If you must call or write, please provide: Model Number, Serial Number, Date of Purchase and a complete description of the problem. Write to:
 - Customer Relations Department
KitchenAid
P.O. Box 558
St. Joseph, MI 49085-0558
5. If you are not satisfied with the action taken, contact the Major Appliance Consumer Action Panel (MACAP). MACAP is a group of independent consumer experts that voices consumer views at the highest levels of the major appliance industry. Contact them only when the dealer, authorized servicer or KitchenAid, Inc., have failed to resolve your problem.
 - Major Appliance Consumer
Action Panel
20 North Wacker Drive
Chicago, IL 60606

MACAP will in turn inform us of your action.

Dishwasher Warranty

LENGTH OF WARRANTY:	KITCHENAID WILL PAY FOR:	KITCHENAID WILL NOT PAY FOR:
ONE YEAR FULL WARRANTY: FROM DATE OF INSTALLATION.	Replacement parts and repair labor to correct defects in materials or workmanship. Service must be provided by an authorized KitchenAid servicing outlet.	A. Service calls to: 1. Correct the installation of the dishwasher. 2. Instruct you how to use the dishwasher. 3. Replace house fuses or correct house wiring. 4. Correct house plumbing.
FIVE YEAR LIMITED WARRANTY: ONE YEAR FULL PLUS SECOND THROUGH FIFTH YEAR LIMITED FROM DATE OF INSTALLATION.	Replacement parts for the upper or lower dishware rack if the rack rusts due to defective materials or workmanship.	B. Repairs when dishwasher is used in other than normal home use. C. Damage resulting from accident, alteration, misuse, abuse, improper installation or installation not in accordance with local electrical and plumbing codes.
FIVE YEAR LIMITED WARRANTY: ONE YEAR FULL PLUS SECOND THROUGH FIFTH YEAR LIMITED FROM DATE OF INSTALLATION.	Replacement parts (repair labor costs not included) for the one-half horsepower motor if defective in materials or workmanship.	D. Any labor costs during the limited warranty.
TEN YEAR LIMITED WARRANTY: ONE YEAR FULL PLUS SECOND THROUGH TENTH YEAR LIMITED FROM DATE OF INSTALLATION.	Replacement parts (repair labor costs not included) for the TriDura® Porcelain-on-steel tank or inner door if the tank or inner door develops a water leak as the result of defective materials or workmanship.	E. Replacement parts or repair labor costs for units operated outside the United States. F. Pickup and delivery. This product is designed to be repaired in the home.

KITCHENAID® DOES NOT ASSUME ANY RESPONSIBILITY FOR INCIDENTAL OR CONSEQUENTIAL DAMAGES.

Some states do not allow the exclusion or limitation of incidental or consequential damages, so this exclusion or limitation may not apply to you.

This warranty gives you specific legal rights and you may also have other rights which vary from state to state.

KITCHENAID®
ST. JOSEPH, MICHIGAN USA 49085

9741157-3/4171675